



REJILLAS DE RETORNO

SERIE 2 - 8 - 9

Las rejillas de retorno, están indicadas para su aplicación en instalaciones de ventilación, calefacción y aire acondicionado. Las series 2 y 8 se configuran como una gran opción para ocultar la oquedad del conducto, gracias a sus aletas fijas y al grado de inclinación de las mismas. A su vez, la serie 9 se presenta como una solución simple y efectiva para retornos ocultos así como las elevadas necesidades de recuperación de caudal.

REJILLAS DE RETORNO

SERIES 2 - 8 - 9

2FH	Rejilla de aletas fijas horizontales a 40°
2FV	Rejilla de aletas fijas verticales a 40°
8FH	Rejilla de aletas fijas planas a 45°
8FT	Rejilla de falso techo modular con aletas fijas a 45°
8FTD	Rejilla de falso techo modular con aletas fijas bidireccionales
9R0	Rejilla de retícula
9RI	Rejilla de retícula a 45°
9RT	Rejilla de falso techo modular de retícula
9RT-2	Rejilla de falso techo modular de retícula a 45°



2FH



2FV



8FT



8FTD



8FH

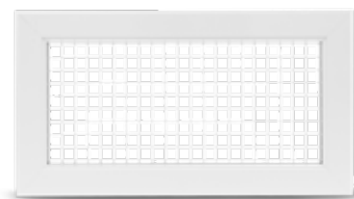

9R0 - 9RI

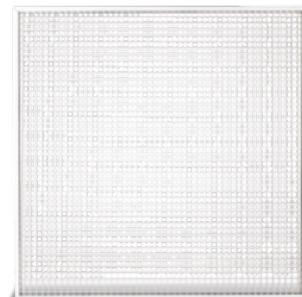

9RT - 9RT-2

SERIE 2F

2FH

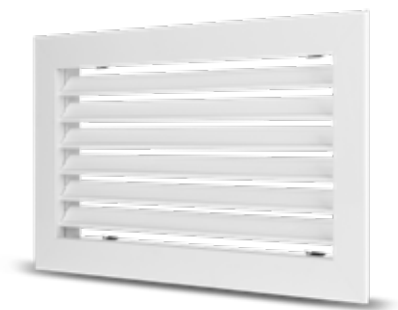

REJILLA DE ALETAS FIJAS A 40°

Modelo **2FH**. Rejilla de aletas fijas horizontales a 40°.

Fabricado en aluminio extruido. Acabados estándar en anodizado plata mate o lacado blanco similar a RAL 9016. Otros colores consultar disponibilidad.

Sistemas de fijación:

- (C) Clip (estándar)
- (T) Tornillo visible (opcional)
Dimensiones de hueco (L-7) x (H-7)
- (P) Pestillo de fijación oculto (opcional)

Accesorios:

- (MM) Marco de montaje de aluminio
Dimensiones de hueco (L+7) x (H+7)
- (X) Compuerta de regulación, de aletas horizontales paralelas a la cota L. Tipo CRX.
- (Z) Compuerta de regulación, de aletas verticales paralelas a la cota H. Tipo CRZ.

2FH

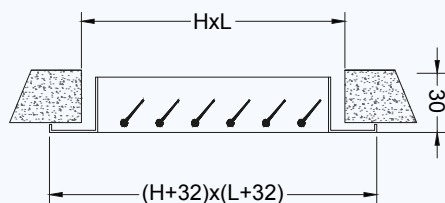

2FHX

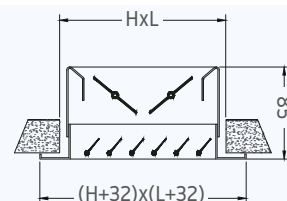

2FHZ

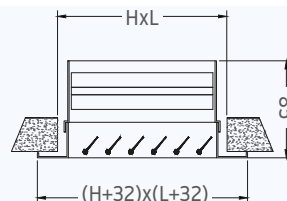

DIMENSIONES NOMINALES NORMALIZADAS

L	200	250	300	400	450	500	600	700	800	900	1000
H	100	150	200	250	300	350	400	500			

SERIE 2F

2FV



REJILLA DE ALETAS FIJAS A 40°

Modelo **2FV**. Rejilla de aletas fijas verticales a 40°.

Fabricado en aluminio extruido. Acabados estándar en anodizado plata mate o lacado blanco similar a RAL 9016. Otros colores consultar disponibilidad.

Sistemas de fijación:

- (C)** Clip (estándar)
- (T)** Tornillo visible (opcional)
Dimensiones de hueco (L-7) x (H-7)
- (P)** Pestillo de fijación oculto (opcional)

Accesorios:

- (MM)** Marco de montaje de aluminio
Dimensiones de hueco (L+7) x (H+7)
- (X)** Compuerta de regulación, de aletas horizontales paralelas a la cota L. Tipo CRX.
- (Z)** Compuerta de regulación, de aletas verticales paralelas a la cota H. Tipo CRZ.

2FV

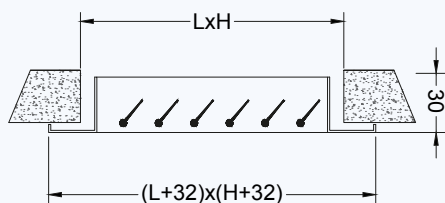

2FVX

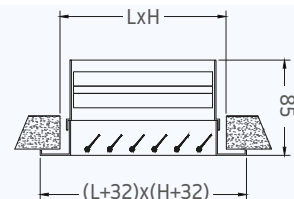

2FVZ

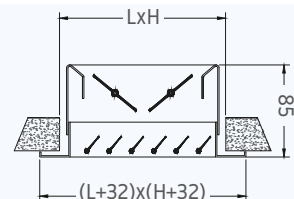

DIMENSIONES NOMINALES NORMALIZADAS

L	200	250	300	400	450	500	600	700	800	900	1000
H	100	150	200	250	300	350	400	500			

SERIE 2F

2FH-2FV

Tabla de Selección

Leyenda:

LxH = Dimensiones en mmxmm

Q = Caudal

Ak = Area efectiva en m²

Vk = Velocidad efectiva en m/s

Pt = Pérdida de carga en Pa

LwA = Potencia sonora en dB(A)

Q (m ³ /h) (l/s)	LxH	200x100	250x100	200x150 300x100	250x150 400x100	200x200 450x100	300x150 500x100	350x150 600x100	450x150 800x100	300x250 400x200 900x100	600x150 1000x100	450x250 600x200 800x150	500x300 600x250 800x200	500x350 600x300 900x200
	Ak	0,010	0,012	0,016	0,020	0,021	0,026	0,031	0,041	0,047	0,052	0,073	0,097	0,113
100 27,8	Vk Pt LwA	2,8 5 12	2,3 4 10	1,7 2 7	1,4 1 5									
150 41,7	Vk Pt LwA	4,2 11 22	3,5 8 18	2,6 4 13	2,1 3 10	2,0 3 10	1,6 2 8							
200 55,6	Vk Pt LwA	5,6 19 31	4,6 14 25	3,5 8 19	2,8 5 15	2,6 5 14	2,1 3 12	1,8 2 10						
250 69,4	Vk Pt LwA	6,9 30 40	5,8 21 33	4,3 12 25	3,5 8 20	3,3 7 19	2,7 5 15	2,2 3 13	1,7 2 10					
300 83,3	Vk Pt LwA	8,3 42 48	6,9 30 40	5,2 17 31	4,2 11 25	4,0 10 23	3,2 7 19	2,7 4 16	2,0 3 13	1,8 2 12				
350 97,2	Vk Pt LwA		8,1 40 48	6,1 23 36	4,9 15 29	4,6 14 28	3,7 9 23	3,1 6 19	2,4 4 15	2,1 3 14	1,9 2 13			
400 111,1	Vk Pt LwA			6,9 30 42	5,6 19 34	5,3 18 32	4,3 12 26	3,6 8 23	2,7 5 18	2,4 4 16	2,1 3 15	1,5 2 12		
450 125,0	Vk Pt LwA			7,8 37 47	6,3 24 38	6,0 22 37	4,8 15 30	4,0 10 26	3,0 6 20	2,7 5 18	2,4 4 17	1,7 2 13		
500 138,9	Vk Pt LwA				6,9 30 43	6,6 27 41	5,3 18 34	4,5 13 29	3,4 7 22	3,0 6 20	2,7 5 18	1,9 2 14	1,4 1 12	
550 152,8	Vk Pt LwA					7,3 32 45	5,9 21 37	4,9 15 32	3,7 9 25	3,3 7 22	2,9 6 20	2,1 3 16	1,6 2 13	
600 166,7	Vk Pt LwA					7,9 38 49	6,4 25 40	5,4 18 34	4,1 11 27	3,5 8 24	3,2 7 22	2,3 3 17	1,7 2 14	
650 180,6	Vk Pt LwA						6,9 30 44	5,8 21 37	4,4 12 29	3,8 9 26	3,5 8 24	2,5 4 19	1,9 2 15	1,6 2 14
700 194,4	Vk Pt LwA						7,5 34 47	6,3 24 40	4,7 14 32	4,1 11 28	3,7 9 26	2,7 5 20	2,0 3 16	1,7 2 15
750 208,3	Vk Pt LwA							6,7 28 43	5,1 16 34	4,4 12 30	4,0 10 28	2,9 5 21	2,1 3 17	1,8 2 16
800 222,2	Vk Pt LwA							7,2 32 46	5,4 18 36	4,7 14 32	4,3 12 29	3,0 6 23	2,3 3 18	2,0 3 17
850 236,1	Vk Pt LwA							7,6 35 49	5,8 21 38	4,7 14 32	4,5 13 31	3,2 7 24	2,4 4 19	2,1 3 18
900 250,0	Vk Pt LwA								6,1 23 40	5,3 18 36	4,8 15 33	3,4 8 25	2,6 4 21	2,2 3 19
950 263,9	Vk Pt LwA								6,4 26 43	5,6 20 38	5,1 16 35	3,6 8 26	2,7 5 22	2,3 4 19
1000 277,8	Vk Pt LwA								6,8 28 45	5,9 22 40	5,3 18 37	3,8 9 28	2,9 5 23	2,5 4 20

SERIE 2F

2FH-2FV

Tabla de Selección

> 51 dB(A)
41 /50 dB(A)
31 /40 dB(A)
21 /30 dB(A)
≤ 20 dB(A)

Q (m³/h) (l/s)	LxH Ak	450x150 800x100	300x250 400x200 900x100	600x150 1000x100	450x250 600x200 800x150	500x300 600x250 800x200	500x350 600x300 900x200	500x400 600x350 700x300	600x400 700x350 1000x250	700x400 1000x300	700x500 1000x350	800x500 1000x400	900x500	1000x500
		0,041	0,047	0,052	0,073	0,097	0,113	0,137	0,163	0,196	0,235	0,279	0,315	0,351
1100 305,6	Vk Pt LwA	7,5 34 49	6,5 26 44	5,9 21 40	4,2 11 30	3,2 6 25	2,7 5 22	2,2 3 20	1,9 2 18	1,6 2 16				
1200 333,3	Vk Pt LwA	8,1 40 53	7,1 31 47	6,4 25 43	4,6 13 33	3,4 8 26	2,9 6 24	2,4 4 21	2,0 3 19	1,7 2 17	1,4 1 16			
1300 361,1	Vk Pt LwA		7,7 36 51	6,9 30 47	4,9 15 35	3,7 9 28	3,2 7 26	2,6 5 22	2,2 3 20	1,8 2 18	1,5 2 17			
1400 388,9	Vk Pt LwA		8,3 42 55	7,5 34 50	5,3 18 38	4,0 10 30	3,4 8 27	2,8 5 24	2,4 4 21	2,0 3 19	1,7 2 18			
1500 416,7	Vk Pt LwA			8,0 39 54	5,7 20 40	4,3 12 32	3,7 9 29	3,0 6 25	2,6 4 23	2,1 3 20	1,8 2 19	1,5 2 17	1,3 1 16	
1600 444,4	Vk Pt LwA			8,5 44 57	6,1 23 43	4,6 13 34	3,9 10 31	3,2 7 27	2,7 5 24	2,3 3 21	1,9 2 19	1,6 2 18	1,4 1 17	
1800 500,0	Vk Pt LwA				6,8 29 48	5,2 17 38	4,4 12 34	3,6 9 29	3,1 6 26	2,6 4 23	2,1 3 21	1,8 2 19	1,6 2 18	1,4 1 18
2000 555,6	Vk Pt LwA				7,6 35 52	5,7 20 42	4,9 15 37	4,1 11 32	3,4 8 29	2,8 5 25	2,4 4 23	2,0 3 21	1,8 2 20	1,6 2 19
2250 625,0	Vk Pt LwA				8,6 44 58	6,4 26 46	5,5 19 41	4,6 13 36	3,8 9 31	3,2 7 28	2,7 5 25	2,2 3 23	2,0 3 21	1,8 2 20
2500 694,4	Vk Pt LwA					7,2 31 51	6,1 23 45	5,1 16 39	4,3 12 34	3,5 8 30	3,0 6 27	2,5 4 24	2,2 3 23	2,0 3 22
2750 763,9	Vk Pt LwA					7,9 38 55	6,8 28 49	5,6 19 42	4,7 14 37	3,9 10 33	3,3 7 29	2,7 5 26	2,4 4 25	2,2 3 23
3000 833,3	Vk Pt LwA						7,4 33 53	6,1 23 46	5,1 16 40	4,3 12 35	3,5 8 31	3,0 6 28	2,6 5 26	2,4 4 25
3500 972,2	Vk Pt LwA							7,1 31 52	6,0 22 46	5,0 15 40	4,1 11 35	3,5 8 31	3,1 6 29	2,8 5 27
4000 1111,1	Vk Pt LwA								6,8 29 51	5,7 20 44	4,7 14 39	4,0 10 35	3,5 8 32	3,2 7 30
4500 1250,0	Vk Pt LwA								7,7 36 56	6,4 25 49	5,3 18 43	4,5 13 38	4,0 10 35	3,6 8 33
5000 1388,9	Vk Pt LwA									7,1 31 53	5,9 22 47	5,0 16 41	4,4 12 38	4,0 10 36

APERTURA DE COMPUERTA

	SIN REGULACIÓN	100%	50%	25%
Pt	x0,5	x1	x2	x5
LwA	+3	+0	+7	+12

SERIE 8F

8FH



REJILLA DE ALETAS FIJAS PLANAS A 45°

Modelo **8FH**. Rejilla de aletas fijas planas horizontales a 45°.

Fabricado en aluminio extruido. Acabados estándar en anodizado plata mate o lacado blanco similar a RAL 9016. Otros colores consultar disponibilidad.

Sistemas de fijación:

- (C) Clip (estándar)
- (T) Tornillo visible (opcional)
Dimensiones de hueco (L-7) x (H-7)
- (P) Pestillo de fijación oculto (opcional)

Accesorios:

- (MM) Marco de montaje de aluminio
Dimensiones de hueco (L+7) x (H+7)
- (X) Compuerta de regulación, de aletas horizontales paralelas a la cota L. Tipo CRX.
- (Z) Compuerta de regulación, de aletas verticales paralelas a la cota H. Tipo CRZ.

8FH

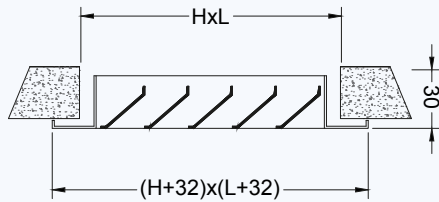

8FHX

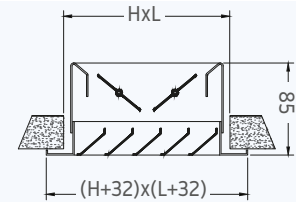

8FHZ

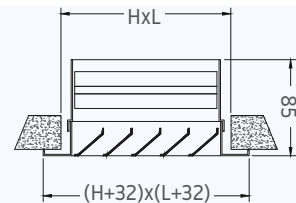

DIMENSIONES NOMINALES NORMALIZADAS

L	200	250	300	400	450	500	600	700	800	900	1000	1100	1200
H	100	150	200	250	300	350	400	500					

SERIE 8F

8FH



REJILLA DE ALETAS FIJAS PLANAS A 45°

Modelo **8FHM**. Rejilla de aletas fijas planas horizontales a 45°, con malla antipájaros.

Modelo **8FHF**. Rejilla de aletas fijas planas horizontales a 45°, con manta filtrante G3.

Fabricado en aluminio extruido. Acabados estándar en anodizado plata mate o lacado blanco similar a RAL 9016. Otros colores consultar disponibilidad.

Sistemas de fijación:

- (C)** Clip (estándar)
- (T)** Tornillo visible (opcional)
Dimensiones de hueco (L-7) x (H-7)
- (P)** Pestillo de fijación oculto (opcional)

Accesorios:

- (MM)** Marco de montaje de aluminio
Dimensiones de hueco (L+7) x (H+7)
- (X)** Compuerta de regulación, de aletas horizontales paralelas a la cota L. Tipo CRX.
- (Z)** Compuerta de regulación, de aletas verticales paralelas a la cota H. Tipo CRZ.

8FHM

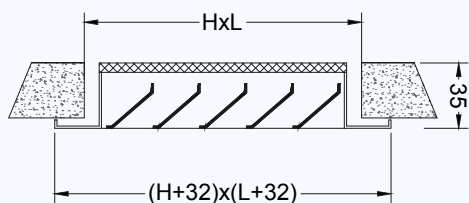

8FHF

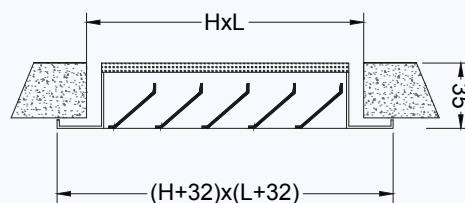

DIMENSIONES NOMINALES NORMALIZADAS

L	200	250	300	400	450	500	600	700	800	900	1000	1100	1200
H	100	150	200	250	300	350	400	500					

* Modelo 8FHF: Dim. máxima 1000x500

SERIE 8F

8FH

Tabla de Selección

Leyenda:

LxH = Dimensiones en mmxmm

Q = Caudal

Ak = Area efectiva en m²

Vk = Velocidad efectiva en m/s

Pt = Pérdida de carga en Pa

LwA = Potencia sonora en dB(A)

Q (m ³ /h) (l/s)	LxH Ak	200x100	250x100	200x150 300x100	250x150 400x100	200x200 300x150 450x100	250x200 350x150	300x200 400x150	500x150 800x100	300x300 1000x100	450x250 600x200 800x150	450x300 700x200 1000x150	500x350 700x250 900x200	500x400 800x250 1000x200
		0,009	0,011	0,014	0,018	0,021	0,026	0,032	0,040	0,048	0,062	0,076	0,097	0,110
100 27,8	Vk Pt LwA	3,1 6 14	2,5 4 11	2,0 3 8	1,5 2 6									
150 41,7	Vk Pt LwA	4,6 14 24	3,8 9 19	3,0 6 15	2,3 4 11	2,0 3 10	1,6 2 8							
200 55,6	Vk Pt LwA	6,2 24 34	5,1 16 28	4,0 10 22	3,1 6 17	2,6 5 14	2,1 3 12	1,7 2 10						
250 69,4	Vk Pt LwA	7,7 36 44	6,3 25 36	5,0 15 28	3,9 10 22	3,3 7 19	2,7 5 15	2,2 3 13	1,7 2 11					
300 83,3	Vk Pt LwA		7,6 35 44	6,0 22 35	4,6 14 27	4,0 10 23	3,2 7 19	2,6 4 16	2,1 3 13	1,7 2 11				
350 97,2	Vk Pt LwA			6,9 30 41	5,4 18 32	4,6 14 28	3,7 9 23	3,0 6 19	2,4 4 16	2,0 3 13	1,6 2 11			
400 111,1	Vk Pt LwA			7,9 38 47	6,2 24 37	5,3 18 32	4,3 12 26	3,5 8 22	2,8 5 18	2,3 4 16	1,8 2 13	1,5 1 11		
450 125,0	Vk Pt LwA			6,9 30 42	6,0 22 37	4,8 15 30	3,9 10 25	3,1 6 21	2,6 4 18	2,0 3 15	1,6 2 13			
500 138,9	Vk Pt LwA			7,7 36 47	6,6 27 41	5,3 18 34	4,3 12 28	3,5 8 23	2,9 5 20	2,2 3 16	1,8 2 14	1,4 1 12		
550 152,8	Vk Pt LwA			7,3 32 45	5,9 21 37	4,8 14 31	3,8 9 25	3,2 7 22	2,5 4 18	2,0 3 15	1,6 2 13			
600 166,7	Vk Pt LwA			7,9 38 49	6,4 25 40	5,2 17 34	4,2 11 28	3,5 8 24	2,7 5 19	2,2 3 17	1,7 2 14			
650 180,6	Vk Pt LwA			6,9 30 44	5,6 20 36	4,5 13 30	3,8 9 26	3,2 7 22	2,5 4 18	2,0 3 15	1,6 2 13			
700 194,4	Vk Pt LwA			7,5 34 47	6,1 23 39	4,9 15 32	4,1 10 28	3,1 6 22	2,6 4 19	2,1 3 16	1,7 2 14			
750 208,3	Vk Pt LwA			6,5 26 42	5,2 17 35	4,3 12 30	3,5 8 24	2,9 5 20	2,2 3 16	1,7 2 14				
800 222,2	Vk Pt LwA			6,9 30 45	5,6 20 37	4,5 13 30	3,8 9 26	3,2 7 22	2,5 4 18	2,0 3 15	1,6 2 13			
850 236,1	Vk Pt LwA			7,4 33 47	6,3 24 41	4,9 15 33	4,1 10 28	3,1 6 22	2,6 4 19	2,1 3 16	1,7 2 14			
900 250,0	Vk Pt LwA			7,8 37 50	6,6 27 44	5,3 18 34	4,3 12 28	3,5 8 23	2,9 5 20	2,2 3 16	1,8 2 14	1,4 1 12		
950 263,9	Vk Pt LwA			6,6 27 43	5,5 19 37	4,3 12 30	3,5 8 26	2,9 5 20	2,2 3 16	1,7 2 14				
1000 277,8	Vk Pt LwA			6,9 30 46	5,8 21 39	4,5 13 32	3,8 9 26	3,2 7 22	2,5 4 18	2,0 3 15	1,6 2 13			

SERIE 8F

8FH

Tabla de Selección

> 51 dB(A)
41 /50 dB(A)
31 /40 dB(A)
21 /30 dB(A)
≤ 20 dB(A)

Q (m³/h) (l/s)	LxH Ak	500x150	300x300	600x200	450x300	500x350	500x400	600x400	600x500	700x500	800x500	700x700	900x600	1000x600
		800x100	1000x100	600x200 800x150	700x200 1000x150	700x250 900x200	800x250 1000x200	700x350 1000x250	1000x300 1200x250	1000x350 1200x300	1000x400	1000x500	1100x500	1100x500
		0,040	0,048	0,062	0,076	0,097	0,110	0,137	0,168	0,200	0,227	0,286	0,313	0,346
1100 305,6	Vk Pt LwA	7,6 36 50	6,4 25 43	4,9 15 35	4,0 10 29	3,2 6 25	2,8 5 22	2,2 3 20	1,8 2 17	1,5 2 16				
1200 333,3	Vk Pt LwA	8,3 42 54	6,9 30 46	5,4 18 38	4,4 12 32	3,4 8 26	3,0 6 24	2,4 4 21	2,0 3 19	1,7 2 17	1,5 1 16			
1300 361,1	Vk Pt LwA		7,5 35 50	5,8 21 40	4,8 14 34	3,7 9 28	3,3 7 26	2,6 5 22	2,1 3 20	1,8 2 18	1,6 2 17			
1400 388,9	Vk Pt LwA		8,1 40 54	6,3 24 43	5,1 16 37	4,0 10 30	3,5 8 28	2,8 5 24	2,3 4 21	1,9 3 19	1,7 2 18			
1500 416,7	Vk Pt LwA		8,7 46 57	6,7 28 46	5,5 19 39	4,3 12 32	3,8 9 29	3,0 6 25	2,5 4 22	2,1 3 20	1,8 2 19	1,5 1 17	1,3 1 16	
1600 444,4	Vk Pt LwA			7,2 32 49	5,8 21 41	4,6 13 34	4,0 10 31	3,2 7 27	2,6 5 23	2,2 3 21	2,0 3 20	1,6 2 18	1,4 1 17	
1800 500,0	Vk Pt LwA			8,1 40 55	6,6 27 46	5,2 17 38	4,5 13 35	3,6 9 29	3,0 6 26	2,5 4 23	2,2 3 22	1,7 2 19	1,6 2 18	1,4 1 18
2000 555,6	Vk Pt LwA				7,3 33 51	5,7 20 42	5,1 16 38	4,1 11 32	3,3 7 28	2,8 5 25	2,4 4 23	1,9 3 21	1,8 2 20	1,6 2 19
2250 625,0	Vk Pt LwA				8,2 41 56	6,4 26 46	5,7 20 42	4,6 13 36	3,7 9 31	3,1 6 27	2,8 5 25	2,2 3 22	2,0 3 21	1,8 2 20
2500 694,4	Vk Pt LwA					7,2 31 51	6,3 25 46	5,1 16 39	4,1 11 34	3,5 8 30	3,1 6 28	2,4 4 24	2,2 3 23	2,0 3 22
2750 763,9	Vk Pt LwA					7,9 38 55	6,9 30 50	5,6 19 42	4,5 13 36	3,8 9 32	3,4 7 30	2,7 5 26	2,4 4 25	2,2 3 23
3000 833,3	Vk Pt LwA						7,6 35 54	6,1 23 46	5,0 15 39	4,2 11 35	3,7 9 32	2,9 6 28	2,7 5 26	2,4 4 25
3500 972,2	Vk Pt LwA							7,1 31 52	5,8 21 44	4,9 15 39	4,3 12 36	3,4 7 31	3,1 6 29	2,8 5 28
4000 1111,1	Vk Pt LwA								6,6 27 50	4,9 15 39	4,3 12 40	3,4 7 34	3,1 6 32	2,8 5 30
4500 1250,0	Vk Pt LwA								7,4 34 55	6,3 24 48	5,5 19 44	4,4 12 38	4,0 10 35	3,6 8 33
5000 1388,9	Vk Pt LwA									6,9 30 53	6,1 23 48	4,9 15 41	4,4 12 38	4,0 10 36

APERTURA DE COMPUERTA

	SIN REGULACIÓN	100%	50%	25%
Pt	x0,5	x1	x2	x5
LwA	+3	+0	+7	+12

MANTA FILTRANTE

	G3	G4
Pt	x3	x3,3

SERIE 8F

8FT



REJILLA DE FALSO TECHO MODULAR

Modelo **8FT**. Rejilla de falso techo modular con aletas fijas planas horizontales a 45°.

Modelo **8FTF**. Rejilla de falso techo modular con aletas fijas planas horizontales a 45°, con manta filtrante G3.

Fabricado en aluminio extruido. Acabados estándar en anodizado plata mate o lacado blanco similar a RAL 9016. Otros colores consultar disponibilidad

Accesorios:

- (X) Compuerta de regulación, de aletas horizontales paralelas a la cota L. Tipo CRX.

8FT

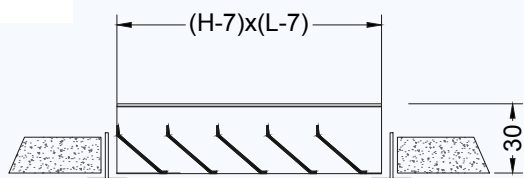

8FTF

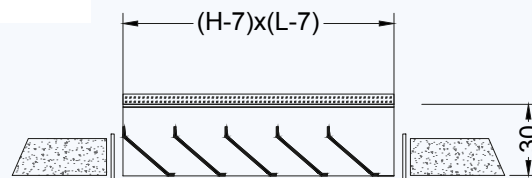

8FTX

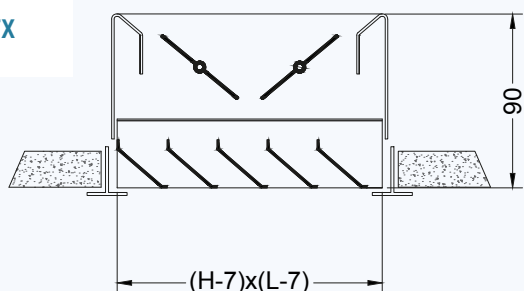

DIMENSIONES NOMINALES NORMALIZADAS

L	600
H	300 600

SERIE 8F

8FT

Tabla de Selección

Leyenda:

LxH = Dimensiones en mmxmm

Q = Caudal

Ak = Area efectiva en m²

Vk = Velocidad efectiva en m/s

Pt = Pérdida de carga en Pa

LwA = Potencia sonora en dB(A)

	> 51 dB(A)
	41 /50 dB(A)
	31 /40 dB(A)
	21 /30 dB(A)
	≤ 20 dB(A)

Q (m ³ /h) (l/s)	LxH	600X300	600X600
	Ak	0,101	0,209
600 166,7	Vk Pt LwA	1,7 2 14	
800 222,2	Vk Pt LwA	2,2 3 18	
1000 277,8	Vk Pt LwA	2,8 5 22	
1200 333,3	Vk Pt LwA	3,3 7 26	1,6 2 17
1400 388,9	Vk Pt LwA	3,9 10 29	1,9 2 19
1600 444,4	Vk Pt LwA	4,4 12 33	2,1 3 21
1800 500,0	Vk Pt LwA	5,0 15 37	2,4 4 23
2000 555,6	Vk Pt LwA	5,5 19 40	2,7 5 24
2500 694,4	Vk Pt LwA	6,9 29 49	3,3 7 29
3000 833,3	Vk Pt LwA		4,0 10 34
3500 972,2	Vk Pt LwA		4,7 14 38
4000 1111,1	Vk Pt LwA		5,3 18 42
4500 1250,0	Vk Pt LwA		6,0 22 47
5000 1388,9	Vk Pt LwA		6,6 27 51
6000 1666,7	Vk Pt LwA		8,0 39 59

APERTURA DE COMPUERTA

	SIN REGULACIÓN	100%	50%	25%
Pt	x0,5	x1	x2	x5
LwA	+3	+0	+7	+12

MANTA FILTRANTE

	G3	G4
Pt	x3	x3,3

SERIE 8F

8FTD



REJILLA DE FALSO TECHO MODULAR

Modelo **8FTD**. Rejilla de falso techo modular con aletas fijas bidireccionales.

Fabricado en aluminio extruido. Acabados estándar en anodizado plata mate o lacado blanco similar a RAL 9016. Otros colores consultar disponibilidad

8FTD

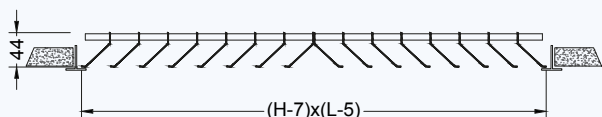

DIMENSIONES NOMINALES NORMALIZADAS

L	600	
H	300	600

SERIE 8F

8FTD

Tabla de Selección

Leyenda:

LxH = Dimensiones en mmxmm





Q = Caudal

Ak = Area efectiva en m²

Vk = Velocidad efectiva en m/s

Pt = Pérdida de carga en Pa

LwA = Potencia sonora en dB(A)

	> 51 dB(A)
	41 /50 dB(A)
	31 /40 dB(A)
	21 /30 dB(A)
	≤ 20 dB(A)

	LxH	300x600	600x600
Q (m ³ /h) (l/s)	Ak	0,130	0,262
1000 277,8	Vk Pt LwA	2,1 3 19	1,1 1 14
1500 416,7	Vk Pt LwA	3,2 7 26	1,6 2 18
2000 555,6	Vk Pt LwA	4,3 12 33	2,1 3 22
2500 694,4	Vk Pt LwA	5,3 18 40	2,7 5 25
3000 833,3	Vk Pt LwA	6,4 25 47	3,2 7 29
3500 972,2	Vk Pt LwA		3,7 9 33
4000 1111,1	Vk Pt LwA		4,2 11 36
4500 1250,0	Vk Pt LwA		4,8 14 40
5000 1388,9	Vk Pt LwA		5,3 18 43
6000 1666,7	Vk Pt LwA		6,4 25 50

SERIE 9R

9R0 - 9RI

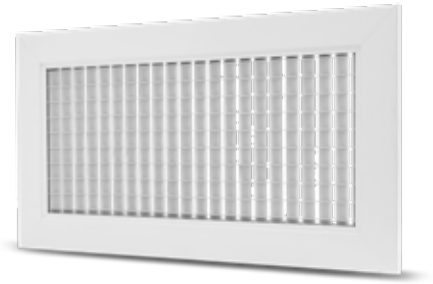

REJILLA DE RETÍCULA

Modelo **9R0**. Rejilla de retícula a 0°.
 Modelo **9RI**. Rejilla de retícula a 45°.

Fabricado en aluminio extruido. Acabados estándar en anodizado plata mate o lacado blanco similar a RAL 9016. Otros colores consultar disponibilidad.

Sistemas de fijación:

- (C)** Clip (estándar)
- (T)** Tornillo visible (opcional)
Dimensiones de hueco (L-7) x (H-7)
- (P)** Pestillo de fijación oculto (opcional)

Accesorios:

- (MM)** Marco de montaje de aluminio
Dimensiones de hueco (L+7) x (H+7).
- (X)** Compuerta de regulación, de aletas horizontales paralelas a la cota L. Tipo CRX.
- (Z)** Compuerta de regulación, de aletas verticales paralelas a la cota H. Tipo CRZ.

9R0

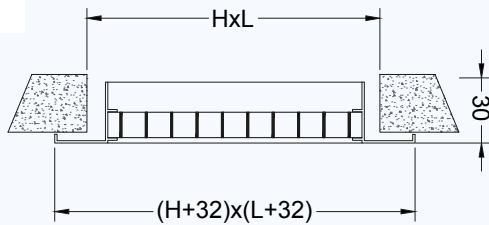

9RI

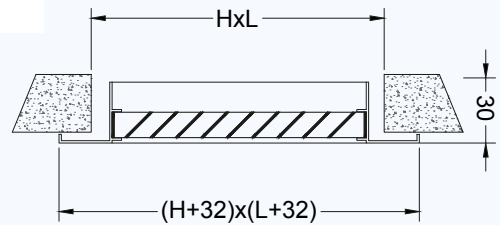

**9R0X
9RIX**

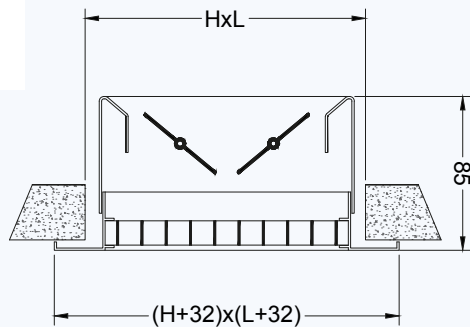

**9R0Z
9RIZ**

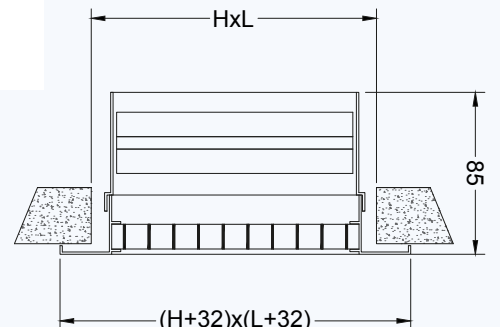

DIMENSIONES NOMINALES NORMALIZADAS

L	200	250	300	350	400	450	500	600	700	800	900	1000	1100	1200
H	100	150	200	250	300	350	400	500	600					

SERIE 9R

9RT - 9RT-2



REJILLA DE RETÍCULA

- Modelo **9RT**. Rejilla de retícula para falso techo modular a 0°.
Modelo **9RT-2**. Rejilla de retícula para falso techo modular a 45°.
Modelo **9RTF**. Rejilla de retícula para falso techo modular a 0°, con manta filtrante G3.
Modelo **9RTF-2**. Rejilla de retícula para falso techo modular a 45°, con manta filtrante G3.

Fabricado en aluminio extruido. Acabados estándar en anodizado plata mate o lacado blanco similar a RAL 9016. Otros colores consultar disponibilidad.

Accesorios:

- (X) Compuerta de regulación, de aletas horizontales paralelas a la cota L. Tipo CRX.

9RT

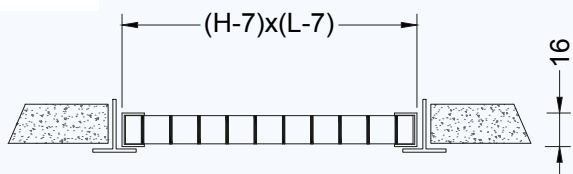

9RT-2

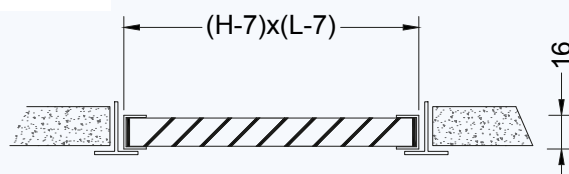

9RTF
9RTF-2

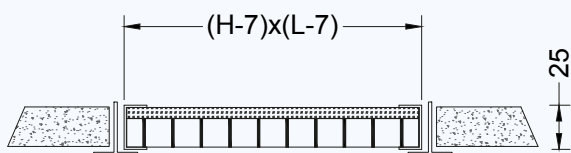

9RTX
9RTX-2

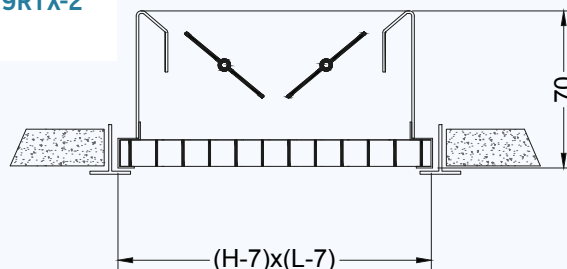

DIMENSIONES NOMINALES NORMALIZADAS

L	600
H	300 600

SERIE 9R

9R0-9R1

Tabla de Selección

Leyenda:

LxH = Dimensiones en mmxmm

Q = Caudal

Ak = Area efectiva en m²

Vk = Velocidad efectiva en m/s

Pt = Pérdida de carga en Pa

LWA = Potencia sonora en dB(A)

Q (m ³ /h) (l/s)	LxH Ak	200x100	250x100	200x150 300x100	250x150 400x100	200x200 450x100	300x150 500x100	350x150 600x100	300x200 400x150 700x100	350x200 500x150 800x100	400x250 500x200 700x150	350x350 500x250 900x150	450x300 700x200 1000x150	500x350 700x250 900x200
		0,011	0,014	0,018	0,024	0,027	0,030	0,037	0,043	0,050	0,074	0,095	0,107	0,136
100 27,8	Vk Pt LWA	2,5 4 11	2,0 3 8	1,5 2 67	1,2 1 4									
150 41,7	Vk Pt LWA	3,8 9 19	3,0 6 15	2,3 4 11	1,7 2 8	1,5 2 7	1,4 1 7							
200 55,6	Vk Pt LWA	5,1 16 28	4,0 10 22	3,1 6 17	2,3 4 13	2,1 3 11	1,9 2 10	1,5 2 8						
250 69,4	Vk Pt LWA	6,3 25 36	5,0 15 28	3,9 10 22	2,9 5 17	2,6 4 15	2,3 4 14	1,9 2 11	1,6 2 10					
300 83,3	Vk Pt LWA	7,6 35 44	6,0 22 35	4,6 14 27	3,5 8 21	3,1 6 19	2,8 5 17	2,3 3 14	1,9 3 12	1,7 2 11				
350 97,2	Vk Pt LWA		6,9 30 41	5,4 18 32	4,1 10 25	3,6 8 22	3,2 7 20	2,6 5 17	2,3 3 15	1,9 3 13	1,3 1 10			
400 111,1	Vk Pt LWA		7,9 38 47	6,2 24 37	4,6 14 28	4,1 11 26	3,7 9 23	3,0 6 19	2,6 4 17	2,2 3 15	1,5 2 11	1,2 1 10		
450 125,0	Vk Pt LWA			6,9 30 42	5,2 17 32	4,6 14 29	4,2 11 26	3,4 7 22	2,9 6 19	2,5 4 17	1,7 2 13	1,3 1 11		
500 138,9	Vk Pt LWA			7,7 36 47	5,8 21 36	5,1 17 32	4,6 14 29	3,8 9 24	3,2 7 22	2,8 5 19	1,9 2 14	1,5 1 12	1,3 1 12	
550 152,8	Vk Pt LWA				6,4 25 40	5,7 20 36	5,1 16 32	4,1 11 27	3,6 8 24	3,1 6 21	2,1 3 16	1,6 2 13	1,4 1 13	
600 166,7	Vk Pt LWA				6,9 30 43	6,2 24 39	5,6 19 36	4,5 13 30	3,9 10 26	3,3 7 23	2,3 3 17	1,8 2 14	1,6 2 14	
650 180,6	Vk Pt LWA				7,5 35 47	6,7 28 42	6,0 23 39	4,9 15 32	4,2 11 28	3,6 8 25	2,4 4 18	1,9 2 16	1,7 2 14	1,3 1 13
700 194,4	Vk Pt LWA					7,2 32 46	6,5 26 41	5,3 17 34	4,5 13 30	3,9 10 27	2,6 5 20	2,0 3 17	1,8 2 15	1,4 1 14
750 208,3	Vk Pt LWA					7,7 36 49	6,9 30 44	5,6 20 37	4,8 15 32	4,2 11 29	2,8 5 21	2,2 3 18	1,9 3 16	1,5 2 14
800 222,2	Vk Pt LWA						7,4 34 47	6,0 22 39	5,2 17 35	4,4 13 30	3,0 6 22	2,3 4 19	2,1 3 17	1,6 2 15
850 236,1	Vk Pt LWA							6,4 25 42	5,5 19 37	4,7 14 32	3,2 7 24	2,5 4 20	2,2 3 18	1,7 2 16
900 250,0	Vk Pt LWA							6,8 28 44	5,8 21 39	5,0 16 34	3,4 7 25	2,6 5 21	2,3 4 19	1,8 2 17
950 263,9	Vk Pt LWA							7,1 31 47	6,1 23 41	5,3 17 36	3,6 8 26	2,8 5 22	2,5 4 20	1,9 3 17
1000 277,8	Vk Pt LWA							7,5 34 49	6,5 26 43	5,6 19 38	3,8 9 27	2,9 6 23	2,6 4 21	2,0 3 18

SERIE 9R

9R0-9R1

Tabla de Selección

> 51 dB(A)
41 /50 dB(A)
31 /40 dB(A)
21 /30 dB(A)
≤ 20 dB(A)

Q (m³/h) (l/s)	LxH Ak	300X200 400X150 700X100	350X200 500X150 800X100	400X250 500X200 700X150	350X350 500X250 900X150	450X300 700X200 1000X150	500X350 700X250 900X200	800X250 1000X200	600X400 800X300 1000X250	600X500 1000X300	800X500 1000X400	800X600 1200X400	1000X600 1200X500	1200X600
		0,043	0,050	0,074	0,095	0,107	0,136	0,153	0,194	0,243	0,332	0,400	0,508	0,614
1100 305,6	Vk Pt LwA	7,1 31 47	6,1 23 41	4,1 11 30	3,2 7 25	2,9 5 23	2,2 3 20	2,0 3 18	1,6 2 16	1,3 1 15				
1200 333,3	Vk Pt LwA	7,8 37 51	6,7 27 45	4,5 13 33	3,5 8 27	3,1 6 25	2,5 4 21	2,2 3 20	1,7 2 17	1,4 1 16	1,0 1 14			
1300 361,1	Vk Pt LwA	8,4 43 55	7,2 32 48	4,9 15 35	3,8 9 29	3,4 7 26	2,7 5 23	2,4 4 21	1,9 2 18	1,5 2 17	1,1 1 15			
1400 388,9	Vk Pt LwA		7,8 37 52	5,3 17 37	4,1 11 31	3,6 8 28	2,9 5 24	2,5 4 22	2,0 3 19	1,6 2 17	1,2 1 15			
1500 416,7	Vk Pt LwA		8,3 42 55	5,6 20 40	4,4 12 33	3,9 10 30	3,1 6 25	2,7 5 24	2,1 3 20	1,7 2 18	1,3 1 16	1,0 1 15	0,8 0 15	
1600 444,4	Vk Pt LwA		8,9 48 59	6,0 22 42	4,7 14 35	4,2 11 32	3,3 7 27	2,9 6 25	2,3 3 21	1,8 2 19	1,3 1 17	1,1 1 16	0,9 1 15	
1800 500,0	Vk Pt LwA			6,8 28 47	5,3 17 39	4,7 14 35	3,7 9 30	3,3 7 27	2,6 4 24	2,1 3 21	1,5 2 18	1,3 1 17	1,0 1 16	0,8 0 15
2000 555,6	Vk Pt LwA			7,5 34 52	5,8 21 42	5,2 17 39	4,1 11 32	3,6 8 30	2,9 5 26	2,3 3 22	1,7 2 19	1,4 1 18	1,1 1 17	0,9 1 16
2250 625,0	Vk Pt LwA			8,4 43 58	6,6 27 47	5,8 21 43	4,6 13 36	4,1 11 33	3,2 7 28	2,6 4 24	1,9 2 21	1,6 2 19	1,2 1 18	1,0 1 17
2500 694,4	Vk Pt LwA				7,3 33 52	6,5 26 47	5,1 16 39	4,5 13 36	3,6 8 30	2,9 5 26	2,1 3 22	1,7 2 21	1,4 1 19	1,1 1 18
2750 763,9	Vk Pt LwA					7,1 31 51	5,6 20 42	5,0 16 39	3,9 10 33	3,1 6 28	2,3 4 24	1,9 2 22	1,5 2 20	1,2 1 19
3000 833,3	Vk Pt LwA					7,8 37 55	6,1 23 46	5,4 19 42	4,3 12 35	3,4 8 30	2,5 4 25	2,1 3 23	1,6 2 21	1,4 1 20
3500 972,2	Vk Pt LwA						7,1 31 52	6,4 25 48	5,0 16 40	4,0 10 34	2,9 6 28	2,4 4 26	1,9 2 23	1,6 2 21
4000 1111,1	Vk Pt LwA							7,3 32 54	5,7 20 45	4,6 13 38	3,3 7 31	2,8 5 28	2,2 3 25	1,8 2 23
4500 1250,0	Vk Pt LwA							8,2 41 59	6,4 26 49	5,1 17 42	3,8 9 34	3,1 6 31	2,5 4 27	2,0 3 25
5000 1388,9	Vk Pt LwA								7,2 31 54	5,7 20 46	4,2 11 37	3,5 8 33	2,7 5 29	2,3 3 26

APERTURA DE COMPUERTA

	SIN REGULACIÓN	100%	50%	25%
Pt	x0,5	x1	x2	x5
LwA	+3	+0	+7	+12

SERIE 9R

9RT - 9RT-2

Tabla de Selección

Leyenda:

LxH = Dimensiones en mmxmm

Q = Caudal

Ak = Area efectiva en m²

Vk = Velocidad efectiva en m/s

Pt = Pérdida de carga en Pa

LwA = Potencia sonora en dB(A)

 41 /50 dB(A) 31 /40 dB(A) 21 /30 dB(A) ≤ 20 dB(A)

Q (m ³ /h) (l/s)	LxH	600x300	600x600
	Ak	0,144	0,302
1000 277,8	Vk Pt LwA	1,9 3 18	0,9 1 13
1500 416,7	Vk Pt LwA	2,9 5 24	1,4 1 17
2000 555,6	Vk Pt LwA	3,9 10 31	1,8 2 20
2500 694,4	Vk Pt LwA	4,8 15 38	2,3 4 23
3000 833,3	Vk Pt LwA	5,8 21 44	2,8 5 27
3500 972,2	Vk Pt LwA	6,8 28 50	3,2 7 30
4000 1111,1	Vk Pt LwA		3,7 9 33
4500 1250,0	Vk Pt LwA		4,1 11 36
5000 1388,9	Vk Pt LwA		4,6 13 39
6000 1666,7	Vk Pt LwA		5,5 19 45

APERTURA DE COMPUERTA

	SIN REGULACIÓN	100%	50%	25%
Pt	X0,5	x1	x2	x5
LwA	+3	+0	+7	+12

MANTA FILTRANTE

	G3	G4
Pt	x3	x3,3

SERIES

2 - 8 - 9

FORMATO DE PEDIDO

DESCRIPCIÓN

Rejilla para retorno de aire con aletas fijas a 45°, tipo 8FH. Compuerta de regulación (CRX) de aletas horizontales paralelas a la cota L, fijación mediante clips (C) de dimensiones LxH y acabado lacado blanco, similar a RAL 9016.

Formato de pedido:

8FH

X

C

LxH

BL



Serie Retorno:

2FH - 2FV
8FH - 8FT
9RO - 9RI
9RT - 9RT-2

Sistemas de fijación:

(C) Clip (estándar)
(T) Tornillo visible (opcional)
(P) Pestillo de fijación oculto (opcional)

Compuerta de regulación:

(X) Compuerta de regulación, de aletas horizontales paralelas a la cota L. Tipo CRX.
(Z) Compuerta de regulación, de aletas verticales paralelas a la cota H. Tipo CRZ.

Marco de montaje:

(MM) Marco de montaje de aluminio.

Dimensiones (LxH):

(L) Longitud (mm)
(H) Altura (mm)

Acabado:

(AL) Aluminio anodizado plata mate
(BL) Aluminio lacado blanco

* Consultar especificaciones y accesorios adaptables en la descripción de cada modelo.