

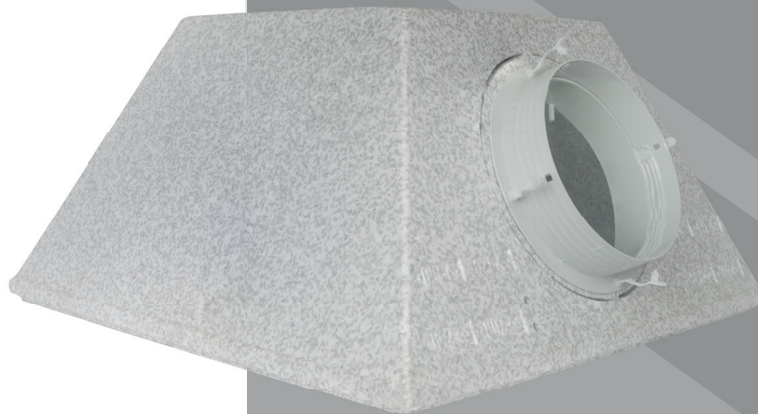

DIFUSIÓN Y VENTILACIÓN



ACCESSORIES

- | | |
|-----------|-----------------------------|
| PPS | Polystyrene Plenum |
| PCL - PCS | Plenum sheet plenum |
| MM | Mounting frame for grilles |
| CR | Control damper for gratings |

PPS PLENUM

POLYSTYRENE PLENUM

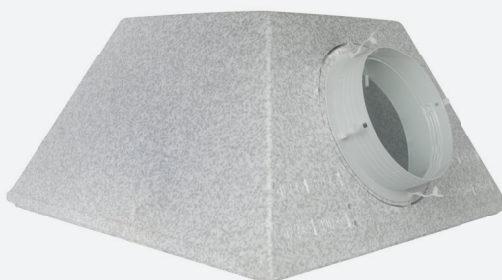

The plenum box model PPS, made of polystyrene foam with a density of 45 Kg/mc, approved according to class 1, is configured as a safe and easy to install option thanks to its lightness and great thermo-acoustic insulation.

Model **PPS-CR.** Polystyrene plenum box with duct connection and regulation damper (790 gr).

Model **PPS-K.** Polystyrene plenum box with duct connection, regulation damper and equalizer plate (990 gr).

Characteristics:

Transmission coefficient 0.0318 W/mk
 High thermal-acoustic insulation.
 Designed to be used with plate diffusers with dimensions 600x600.
 Duct connection diameters: Ø160, Ø200, Ø250.
 Possibility of incorporating ceiling fixing bracket, model CH-PPS.
 Supplied disassembled to optimise storage and transport.
 Easy installation, thanks to its lightness.
 Time saving in installation.
 Space saving of 50% compared to traditional plenum

Accessories:

CH-PPS.

PPS plenum ceiling fixing bracket.

PPS

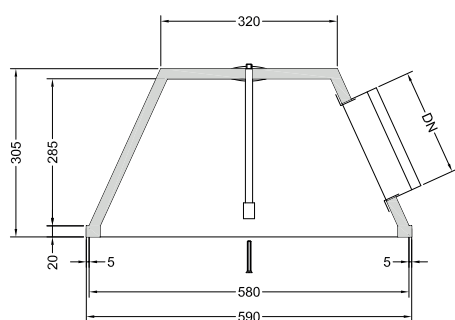

Front

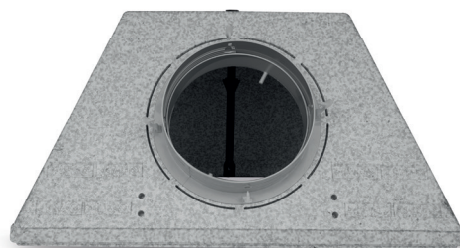

DESCRIPTION

Polystyrene plenum box with duct connection and regulation damper, type PPS-CR Ø 200 and ceiling fixing bracket type CH-PPS.

Order form:

PPS-CR

Ø 200

CH-PPS

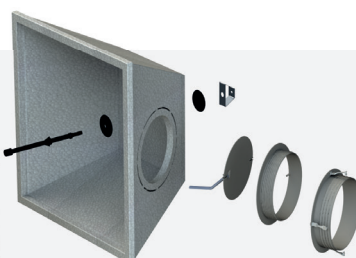

PC
PCL - PCS
METAL SHEET PLENUM

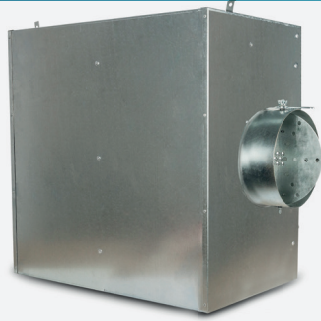

Model **PC**. Plenum box in galvanised sheet metal, with butterfly damper and mounting bracket for swirl diffuser. Includes hanging plates for ceiling mounting.

Accesorios:

- (PCL)** Plenum box for square plate with side connection
- (PCL-A)** Plenum box for square panel with side entry, insulated.
- (PCS)** Plenum box for square plate with top connection.
- (PCS-A)** Plenum box for square plate with top connection, insulated.

- (PCLR)** Plenum box for circular plate with side connection.
- (PCLR-A)** Plenum box for circular plate with side connection, insulated.
- (PCSR)** Plenum box for circular plate with top connection.
- (PCSR-A)** Plenum box for circular plate with top connection, insulated.

PCL

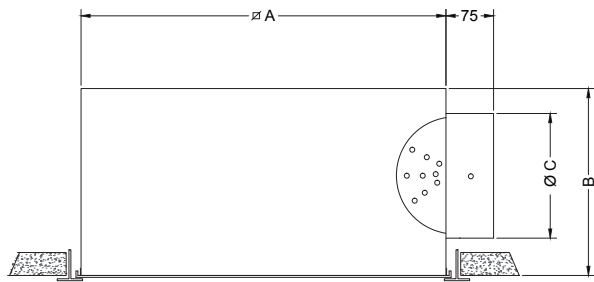

PCLR

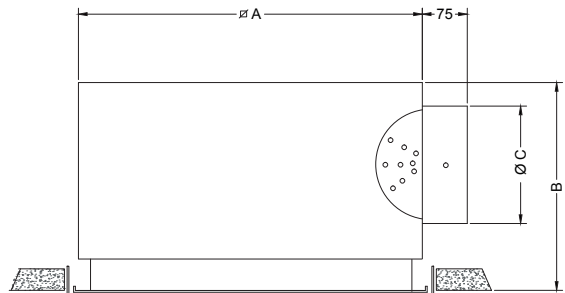

	∅ A	B	∅ C
PCL 400	375	250	160
PCL 500	475	318	200 - 250
PCL 600	575	350	200 - 250
PCS 400	375	325	160
PCS 500	475	393	200 - 250
PCS 600	575	425	200 - 250

	∅ A	B	∅ C
PCLR 400	375	295	160
PCLR 500	475	363	200 - 250
PCLR 600	575	395	200 - 250
PCSR 400	375	370	160
PCSR 500	475	438	200 - 250
PCSR 600	575	470	200 - 250

DESCRIPTION

Plenum box with insulated side entry connection, for panel 600. Type PCL-A 600 - 200

Order form:

PCL-A

600

200

Plenum sheet metal series:

PCL PCLR PCS PCSR
PCL-A PCLR-A PCS-A PCSR-A

∅ of plate:

400 / 500 / 600

∅ collar:

160 / 200 / 250

CR
CRX - CRZ
REGULATION DAMPER



The **CR** regulation dampers are manufactured with an extruded aluminium frame to offer great resistance to the assembly. The movable blades opposite each other are made of both aluminium and PVC. The opening and closing system consists of gears connected to a manually operated worm screw. It is arranged for the adjustment of the blades in the required position. Thanks to the worm screw the position of the blades will not suffer changes in their degree of inclination when acting as a lever, the CR regulation is coupled to the internal face of the grille by means of fixing clips.

Modelo **CRX**. Regulation damper, with horizontal fins parallel to the level L.
Slats built in PVC up to L=300 and in Aluminium for L≥350

Modelo **CRZ**. Regulation damper, with vertical blades parallel to the H level. Blades manufactured in PVC up to H=300 and in Aluminium for H ≥350

CRX

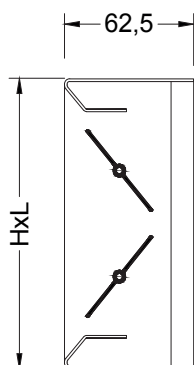

CRZ

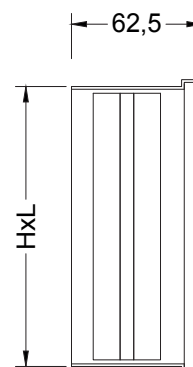

CRX STANDARDIZED NOMINAL DIMENSIONS

L	200	250	300	700	350	400	450	500	600
H	100	150	200	250	300	350	400	500	

CRZ STANDARDIZED NOMINAL DIMENSIONS

L	200	250	300	700	350	400	450	500	600		
H	50	75	100	125	150	200	250	300	350	400	500



MM
MM
MOUNTING FRAME



Model **MM**. Mounting frame for grilles.

Made of extruded aluminium.
High resistance and easy installation.
Fixing plates for plaster plates from 15 to 18mm.

MM

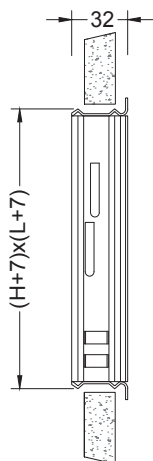

MM

Detail of mounting frame

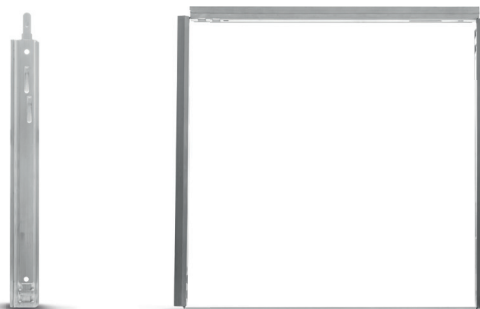
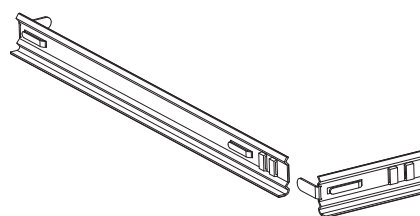

STANDARDIZED NOMINAL DIMENSIONS

L	50	75	100	125	150	200	250	300	350	400	450
	500	600	700	800	900	1000	1100	1200	1300	1400	1500

SIMBOLOGY

TECHNICAL ICONS



SUPPLY



RETURN



SWIRL



MULTIDIRECTIONAL



LONG RANGE



ACCESSORIES



SQUARED



ROUND



LINEAR



FIX



ADJUSTABLE



CEILING



FALSE CEILING



WALL



FLOOR



TRANSIT



DUCT



OUTER/EXTERNAL



FIRE



DAMP



SMOKE





SAMOVENT TECHNIK®

T. 961 061 876

Acequia Mislata 12. 46200.
Paiporta. Valencia

www.samovent.com